

Article number: 53090108

Description: KLEE Hydraulic lubricating nipple DIN 71412
H1 straight, M10x1,5

Measures

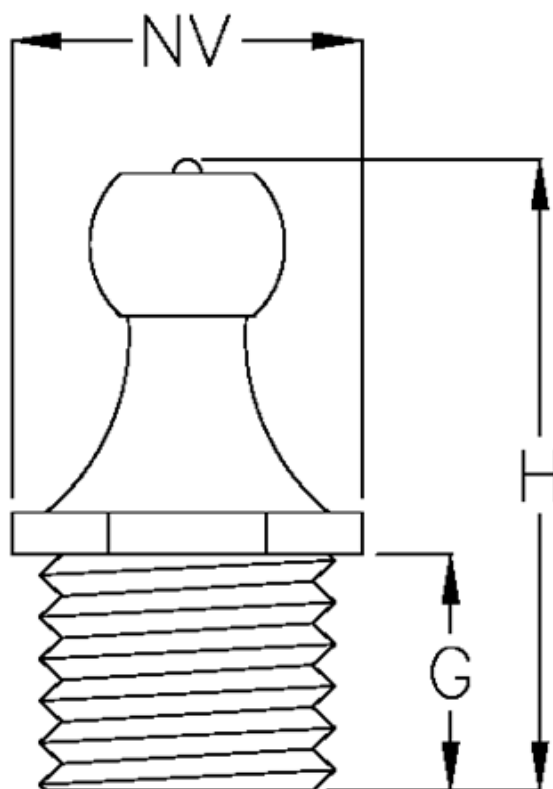

G = 5,4

H = 15

NV = 10,9

Thread = M10x1,5